

# Serie Civili

## Wiring accessories

Industrial design Patent n°250





DESCRIZIONE DESCRIPTION	PAGINE PAGES
<b>COMANDI</b> CONTROL DEVICES	<b>30</b>
<b>PRESE - PRESE DATI</b> SOCKETS - DATA / TV SOCKETS	<b>32</b>
<b>PLACCHE</b> FRONT PLATES	<b>34</b>
<b>SUPPORTI</b> FRAMES	<b>36</b>



Il sistema consiste in un aggancio innovativo e brevettato che si basa sulla particolare elasticità del materiale del telaio, garantendo facilità di inserimento e disinserimento del frutto dal telaio stesso, tramite linguetta a resilienza elevata e garantita nel tempo. L'aggancio della placca sul telaio è pure innovativo ed utilizza, diversamente da quanto in uso, una lingua centrale posta in un solo lato del telaio, ai fini dello sgancio della placca.

*The New Coupling System is an innovative and patented clipping based on the peculiar elasticity of the material of the frame, it grants long lasting ease of insertion and removal of the modules from the frame itself by means of a highly resilient flap. The plate clipping is also innovative and, differently from common practice, uses just one single tab placed in central position along one side of the plate to allow the plate removal.*

# Comandi RAL 9016

RAL 9016 Control devices

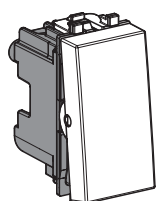

codice <i>code</i>	descrizione <i>description</i>		
<b>43B001</b>	Interruttore 1P 16AX - 1 modulo <i>1P 16AX one way switch - 1 module</i>	10	250

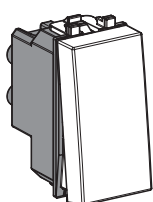

codice <i>code</i>	descrizione <i>description</i>		
<b>43B010</b>	Interruttore 2P 16AX - 1 modulo <i>2P 16AX one way switch - 1 module</i>	10	250

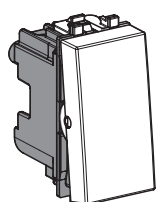

codice <i>code</i>	descrizione <i>description</i>		
<b>43B002</b>	Deviatore 1P 16AX - 1 modulo <i>1P 16AX two way switch - 1 module</i>	10	250

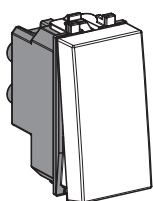

codice <i>code</i>	descrizione <i>description</i>		
<b>43B004</b>	Invertitore 1P 16AX - 1 modulo <i>1P 16AX intermediate switch - 1 module</i>	10	250

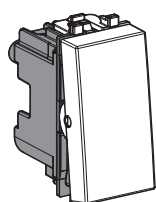

codice <i>code</i>	descrizione <i>description</i>		
<b>43B005</b>	Pulsante 1P NA 10A - 1 modulo <i>1P NO 10A push-button - 1 module</i>	10	250

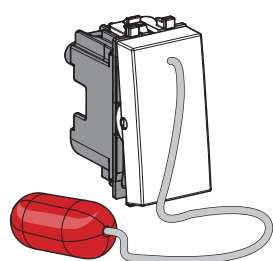

codice <i>code</i>	descrizione <i>description</i>		
<b>43B017</b>	Pulsante 1P NA+NC 10A a tirante - cordone in materiale isolante 1,5m - 1 modulo <i>1P NO+NC 10A cord push-button - insulating material cord 1,5 m - 1 module</i>	10	250

Disponibile a breve  
Coming soon

# Comandi RAL 9016

RAL 9016 Control devices

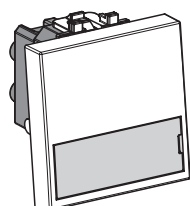

codice code	descrizione description		
<b>43B088</b>	1 Pulsante con targhetta portanome 1P NO 10A illuminabile - 2 moduli P NO 10A lightable single pole push-button with neon and name tag label 2 modules	1	1

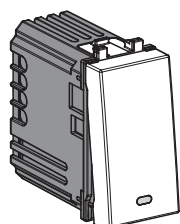

codice code	descrizione description		
<b>43B048UL</b>	Regolatore di luminosità 230V~ 50-60 Hz per carichi resistivi e induttivi (lampade ad incandescenza e alogene 3-220W, trasformatori elettronici 20-220W, lampade LED 3-120W, lampade CFL 3-220W - alimentatori elettronici LED a taglio di fase) - comando e regolazione con pulsante incorporato o da più punti con normali pulsanti NA - led di individuazione al buio a basso consumo - memorizzazione dello stato e del livello dell'uscita in caso d'interruzione di rete - 1 modulo 230V~ 50-60 Hz dimmer for resistive and inductive loads (3-220W incandescent and halogen lamps, ferromagnetic transformers 20-220W, LED lamps 3-120W, CFL lamps 3-220W - electronic ballasts for LED with line interruption) - control and regulation by built-in push-button or by normal NO push-button from more points - low consumption led for identification in the dark - status and level memory in case of blackout - 1 module	1	1

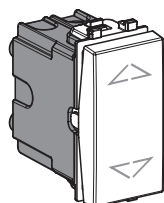

codice code	descrizione description		
<b>43B051BS</b>	Commutatore a bascula 1P 10AX 3 posizioni (OFF centrale) con frecce direzionali - 1 modulo 1P 10AX rolling blind switch 3 positions (central OFF) with arrows - 1 module	10	250

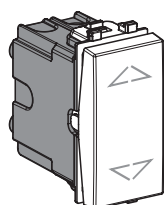

codice code	descrizione description		
<b>43B053BS</b>	Commutatore pulsante a bascula 1P 10A 3 posizioni con frecce direzionali - 1 modulo 1P 10A rolling blind push-button 3 positions (central OFF) with arrows - 1 module	10	250

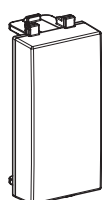

codice code	descrizione description		
<b>43B013</b>	Tappo copriforo - pretranciatura posteriore centrale per agevolare eventuali fori - 1 modulo Blank insert - central pre-cut in rear side to facilitate any holes - 1 module	48	480

# Prese - prese dati - TV - RAL 9016

RAL 9016 - Sockets - data / TV sockets

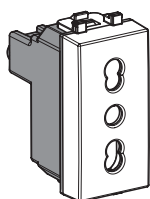

codice code	descrizione description		
43B006-15TS	Presa bipasso P17/11 2P+T 10/16A - alveoli schermati - 1 modulo <i>Combined P17/11 Italian standard socket 2P+E 10/16A - shuttered - 1 module</i>	10	250

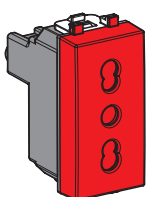

codice code	descrizione description		
43B006-15TSR	Presa bipasso rossa P17/11 2P+T 10/16A - alveoli schermati - 1 modulo <i>Combined P17/11 red Italian standard socket 2P+E 10/16A - shuttered - 1 module</i>	10	250

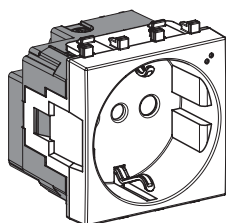

codice code	descrizione description		
43B090TS	Presa schuko P30 2P+T 16A - alveoli schermati - illuminabile (segnalazione presenza rete) - contatti di terra laterale e centrale - 2 moduli <i>P30 2P+E 16A Schuko socket - shuttered - lightable (indicating the presence of the line) - lateral and central earth contacts - 2 modules</i>	5	125

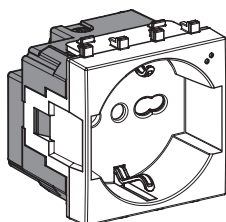

codice code	descrizione description		
43B090/15TS	Presa schuko bipasso (UNIVERSALE) 2P+T 10/16A - alveoli schermati - illuminabile (segnalazione presenza rete) - 2 moduli <i>2P+E 10/16A (UNIVERSAL) combined Schuko + Italian standard socket - shuttered - lightable (indicating the presence of the line) - 2 modules</i>	5	125

Disponibile a breve  
Coming soon

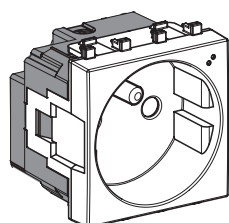

codice code	descrizione description		
43B092TS	Presa standard francese 2P+T 16A 250V~ - alveoli schermati - con terra - illuminabile (segnalazione presenza rete) - 2 moduli <i>2P+E 16A 250 V~ French standard socket - shuttered - with earth - lightable (indicating the presence of the line) - 2 modules</i>	5	125

Prodotto per Export  
For Export only

Disponibile a breve  
Coming soon

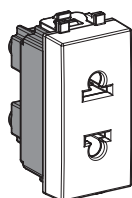

codice code	descrizione description		
43B033	Presa polarizzata euroamericana 2P 16A 250V~ - alveoli non schermati - 1 modulo <i>2P 16A 250V~ Euro-American polarized socket - not shuttered - 1 module</i>	10	250

Prodotto per Export  
For Export only

# Prese - prese dati - TV - RAL 9016

RAL 9016 - Sockets - data / TV sockets

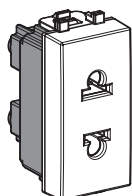

codice code	descrizione description		
<b>43B033S</b> Prodotto per Export For Export only	Presa polarizzata euroamericana 2P 16A 250V~ - alveoli schermati - 1 modulo <i>2P 16A 250V~ Euro-American polarized socket - shuttered - 1 module</i>	<b>10</b>	<b>250</b>

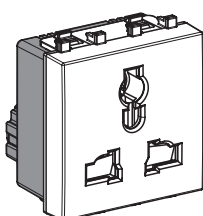

codice code	descrizione description		
<b>43B059TS</b> Prodotto per Export For Export only	Presa multistandard 2P+T 5/6/10/13A 250V~ - alveoli schermati - 2 moduli <i>2P+E 5/6/10/13A 250V~ multistandard socket - shuttered - 2 modules</i>	<b>10</b>	<b>10</b>

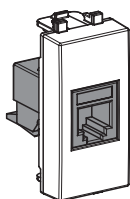

codice code	descrizione description		
<b>43B024</b>	Presa telefonica RJ11 (6 poli / 4 contatti) - 1 modulo <i>RJ11 Telephone socket (6 poles / 4 contacts) - 1 module</i>	<b>1</b>	<b>1</b>

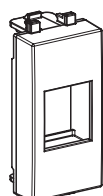

codice code	descrizione description		
<b>43B029SC</b>	Adattatore per connettori RJ11, RJ45, TV - 1 modulo <i>Adaptor for RJ45, RJ11, TV, with clipping to keystone - 1 module</i>	<b>4</b>	<b>4</b>

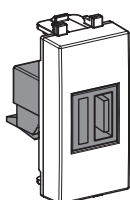

codice code	descrizione description		
<b>43B082USB-2A</b>	Caricatore USB universale 5V 2,1A - n° 1 uscita USB frontale - alimentazione 110÷240V~ 50-60 Hz - assorbimento a riposo < 0,1 W - consente la ricarica di telefoni cellulari, riproduttori audio portatili, console portatili e ogni altro apparecchio elettronico che offra la possibilità di ricarica da una qualsiasi presa standard USB - 1 modulo <i>Universal USB charger 5V 2,1A - 1 frontal USB output - powered with 110÷230V~ 50-60 Hz - stand-by consumption &lt; 0,1 W - It allows the charging of mobile phones, mobile audio player, and all electronic devices with charging system through standard USB Inputs - 1 module</i>	<b>1</b>	<b>1</b>

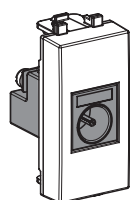

codice code	descrizione description		
<b>43B091</b>	Preso TV resistiva diretta con porta utente IEC 60169-2 femmina - per frequenze 40÷862 MHz - collegamento in ingresso mediante morsetto a vite - 1 modulo <i>Direct TV socket with IEC 60169-2 female connector - frequency range 40÷862 MHz - incoming connection with screw terminal - 1 module</i>	<b>1</b>	<b>1</b>

## Colori placche

*Front plates colours*



**43BP03NAL**

Nero  
*Black*

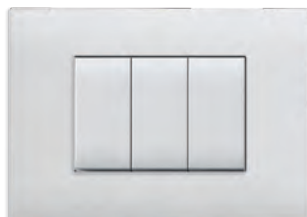

**43BP03BB**

Bianco Banquise RAL 9016  
*RAL 9016 Banquise white*



**43BP03CHO**

Champagne opaco  
*Matt Champagne*

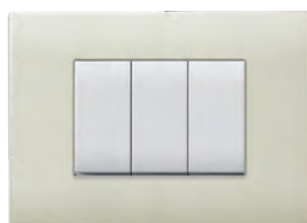

**43BP03SA**

Biaco Blanc RAL 1013  
*RAL 1013 Blanc white*



**43BP03RD**

Radica opaca  
*Matt Briarwood*



**43BP03BZ**

Bronzo opaco  
*Matt Bronze*





**43BP03AO**

Argento opaco  
*Matt Silver*

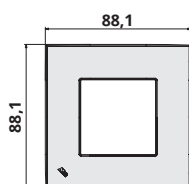

# Colori placche

## Front plates colours



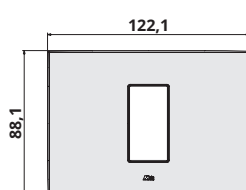

codice code	descrizione description		
<b>43BP32..</b> cod. color NAL - BB - CHO - SA - RD - BZ - AO	Placca per scatola tonda o quadrata - 2 moduli Moulded front plate for square or round box - 2 modules	15	150



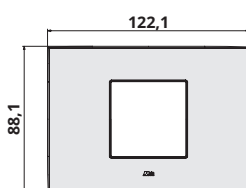

codice code	descrizione description		
<b>43BP01..</b> cod. color NAL - BB - CHO - SA - RD - BZ - AO	Placca per scatola rettangolare - 1 modulo Moulded front plate for rectangular box - 1 module	10	100



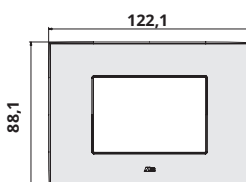

codice code	descrizione description		
<b>43BP02..</b> cod. color NAL - BB - CHO - SA - RD - BZ - AO	Placca per scatola rettangolare - 2 moduli Moulded front plate for rectangular box - 2 modules	10	100



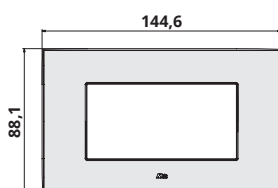

codice code	descrizione description		
<b>43BP03..</b> cod. color NAL - BB - CHO - SA - RD - BZ - AO	Placca per scatola rettangolare - 3 moduli Moulded front plate for rectangular box - 3 modules	10	100

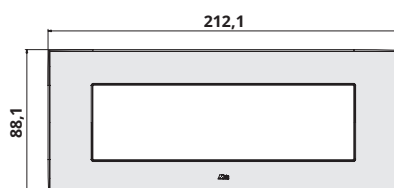

codice code	descrizione description		
<b>43BP04..</b> cod. color NAL - BB - CHO - SA - RD - BZ - AO	Placca per scatola rettangolare - 4 moduli Moulded front plate for rectangular box - 4 modules	10	100



codice code	descrizione description		
<b>43BP07..</b> cod. color NAL - BB - CHO - SA - RD - BZ - AO	Placca per scatola rettangolare - 7 moduli Moulded front plate for rectangular box - 7 modules	5	50



# Supporti per scatole tonde, quadrate e rettangolari

Frames for round, square and rectangular boxes

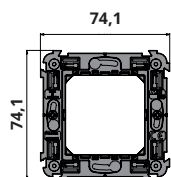

codice code	descrizione description		
43BA02VT	Supporto 1-2 moduli per scatola quadrata o tonda - con viti agganciate in modo imperdibile al supporto - installabile su scatole con interasse 60 mm o 56x56 mm <i>1-2 modules frame for round or square box - with screws hooked to the frame - can be installed on boxes with centre distance of 60 mm or 56x56 mm</i>	12	120

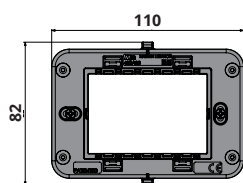

codice code	descrizione description		
43BA03	Supporto 3 moduli per scatole 2503MG, 253CG e 253GB - con viti <i>frame for rectangular 3 modules boxes - with screws</i>	100	100

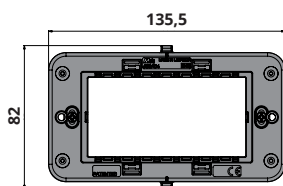

codice code	descrizione description		
43BA04	Supporto 4 moduli per scatola 2504 e 254CG - con viti <i>frame for rectangular 4 modules boxes - with screws</i>	80	80

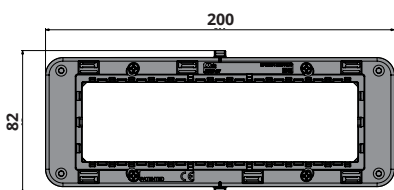

codice code	descrizione description		
43BA07	Supporto 7 moduli per scatola 2506 e 256CG - con viti <i>frame for rectangular 7 modules boxes - with screws</i>	40	40



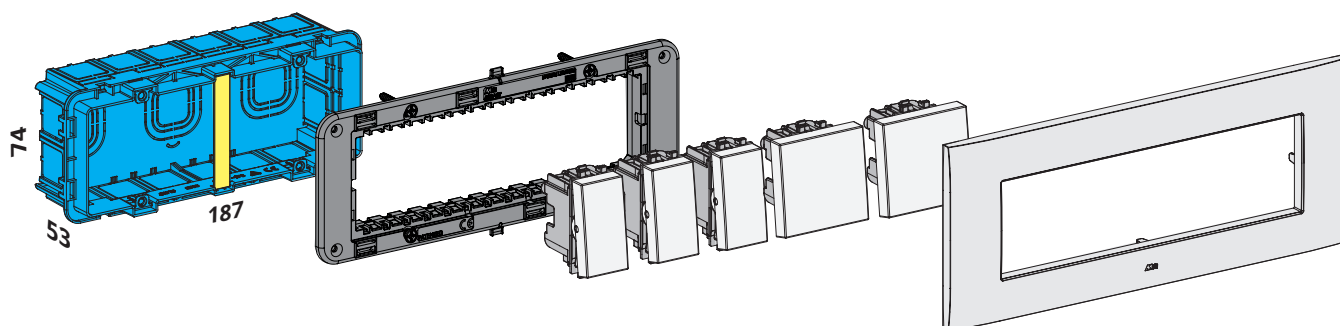
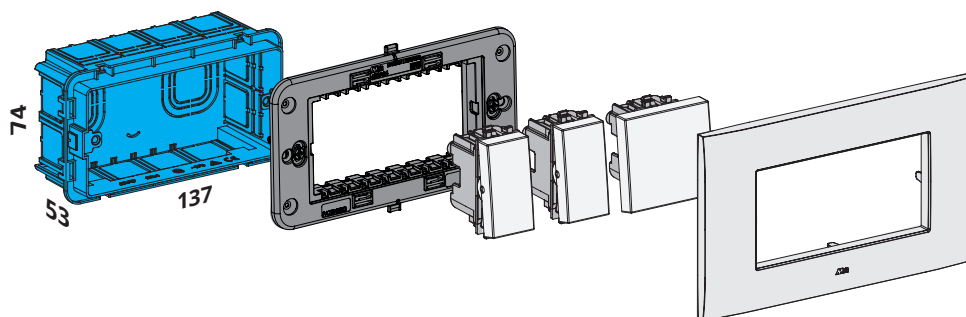
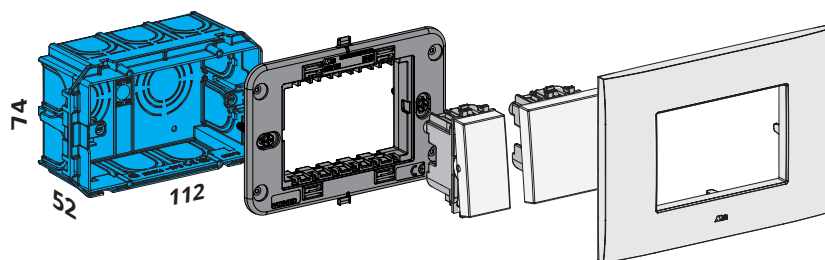
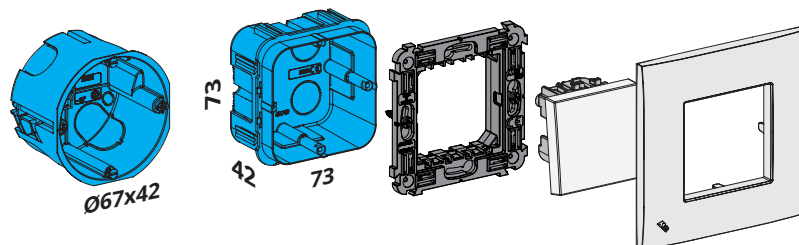

# Contenitori da parete autoportanti IP40 RAL 9010 per tubo

IP40 wall mounted enclosures RAL9010  
for duct- self-supporting



codice <i>code</i>	descrizione <i>description</i>		
43BQ01	Contenitore da parete autoportante - 1 mod. <i>Wall mounted self supporting enclosure - 1 mod.</i>	42	42



codice <i>code</i>	descrizione <i>description</i>		
43BQ02	Contenitore da parete autoportante - 2 mod. <i>Wall mounted self supporting enclosure - 2 mod.</i>	42	42



codice <i>code</i>	descrizione <i>description</i>		
43BQ03	Contenitore da parete autoportante - 3 mod. <i>Wall mounted self supporting enclosure - 3 mod.</i>	24	24



codice <i>code</i>	descrizione <i>description</i>		
43BQ04	Contenitore da parete autoportante - 4 mod. <i>Wall mounted self supporting enclosure - 4 mod.</i>	22	22



codice <i>code</i>	descrizione <i>description</i>		
43BQ06	Contenitore da parete autoportante - 6 mod. <i>Wall mounted self supporting enclosure - 6 mod.</i>	1	15



# Contenitori da parete autoportanti IP40 RAL 9010 per tubo

IP40 wall mounted enclosures RAL 9010  
for duct- self-supporting



codice code	descrizione description		
43BQ0102 	Contenitore da parete autoportante con deviatore - 1 mod. <i>Wall mounted self-supporting enclosure with two way switch - 1 mod</i>	5	5



codice code	descrizione description		
43BQ0202 	Contenitore da parete autoportante con doppio deviatore - 2 mod. <i>Wall mounted self-supporting enclosure with 2 pcs two way switch - 1 mod</i>	5	5



codice code	descrizione description		
43BQ0106/15 	Contenitore da parete autoportante con presa bipasso - 1 mod. <i>Wall mounted self-supporting enclosure with combined P17/11 Italian standard socket 2P+E 10/16A - 1 mod</i>	5	5



codice code	descrizione description		
43BQ0290/15 	Contenitore da parete autoportante con presa schuko - 2 mod. <i>Wall mounted self-supporting enclosure with 2P+E 10/16A combined schuko+Italian standard socket - 2 mod</i>	5	5



codice code	descrizione description		
43BQ020206/15 	Contenitore da parete autoportante con deviatore e presa bipasso - 2 mod. <i>Wall mounted self-supporting enclosure with two way switch and combined Italian standard socket 2P+E 10/16A - 2 mod</i>	5	5





codice code	descrizione description		
43BQ0224/USB 	Contenitore da parete autoportante con presa RJ11 e USB - 2 mod. <i>Wall mounted self-supporting enclosure with RJ11 telephone socket and universal USB charger - 2 mod</i>	5	5



# Scatole universali IP40 colore RAL 9010 per minicanali

*IP40 Universal boxes RAL 9010 for mini trunkings*



codice <i>code</i>	descrizione <i>description</i>		
<b>43BSC03</b>	3 moduli - da utilizzare con supporti standard 3 moduli (interasse 83,5 mm) - per minicanali da 20x10 mm a 30x18 mm  <i>3 modules - to be used with standard 3 module frames (centre distance 83,5 mm) for trunking from 20x10 mm to 30x18 mm</i>	<b>27</b>	<b>27</b>



codice <i>code</i>	descrizione <i>description</i>		
<b>43BSC04</b>	4 moduli - da utilizzare con supporti standard 4 moduli (interasse 108 mm) - per minicanali da 20x10 mm a 30x18 mm  <i>4 modules - to be used with standard 4 module frames (centre distance 108 mm) for trunking from 20x10 mm to 30x18 mm</i>	<b>20</b>	<b>20</b>

Per minicanali  
da 20x10 mm a 30x18 mm  
*For mini trunking  
from 20x10 mm to 30x18 mm*

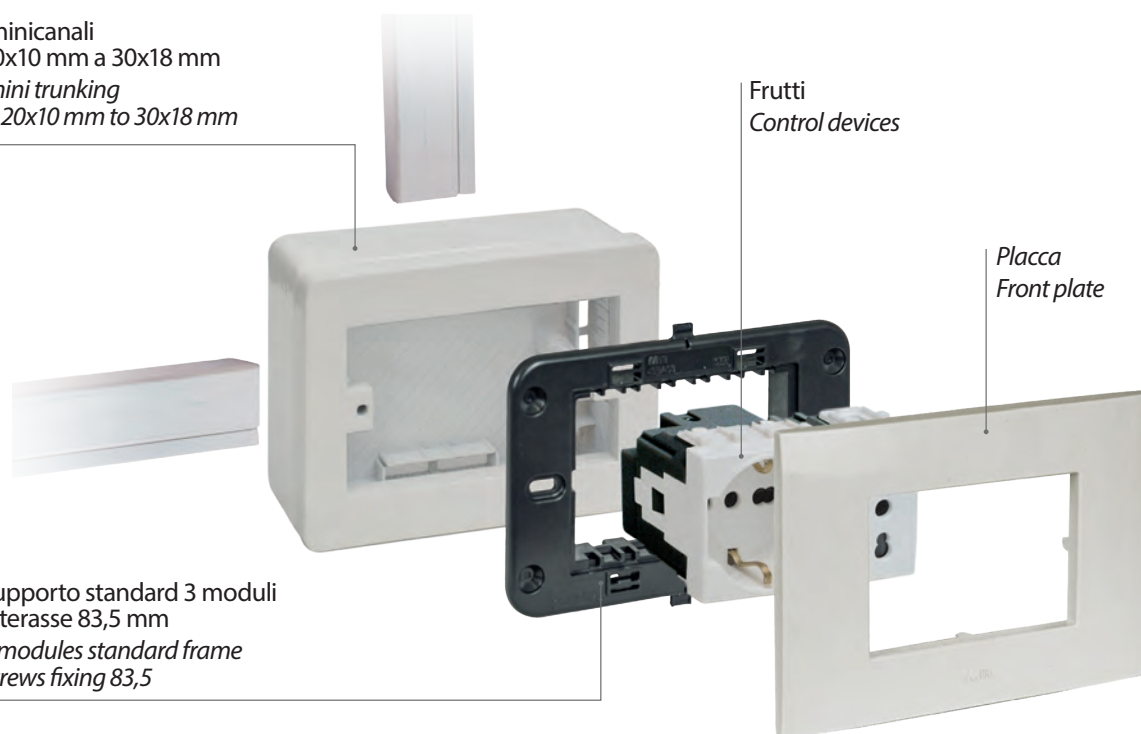

# Dimensioni

Dimensions

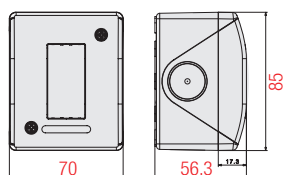

44BQ01

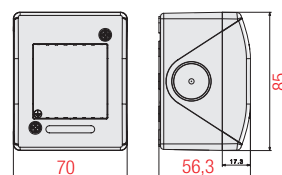

44BQ02

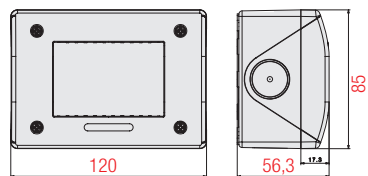

44BQ03

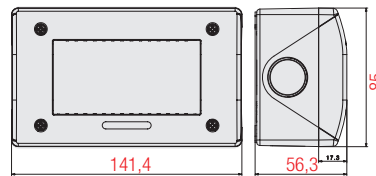

44BQ04

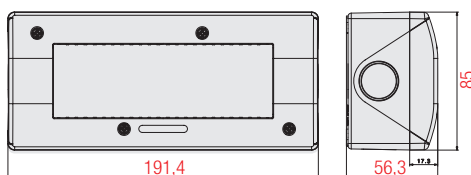

44BQ06

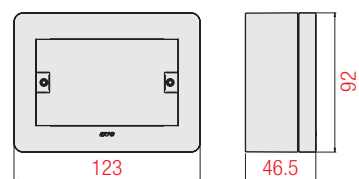

44BSC03

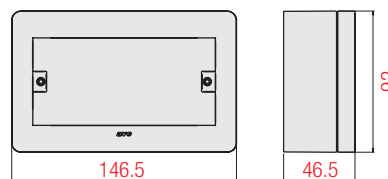

44BSC04